

Ficha de datos | Código: 222-412

Borna de conexión CLASSIC; para cualquier tipo de conductor; máx. 4mm²; 2 conductores; con palancas de accionamiento; Carcasa gris; Temperatura ambiente máxima 40°C; 2,50 mm²; gris

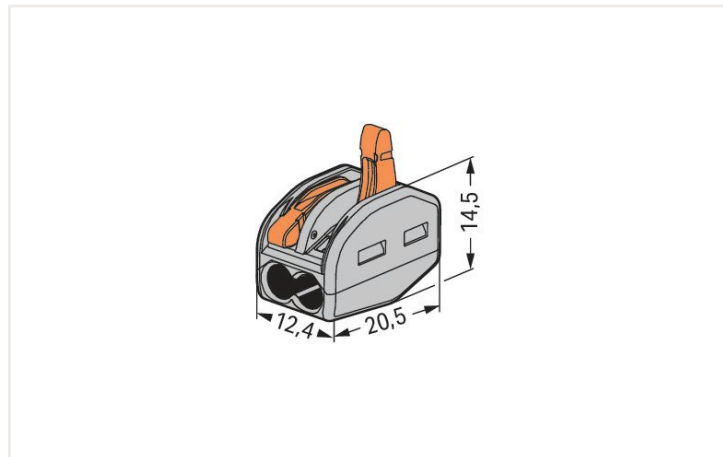

Dimensiones en mm

Notas

Información sobre seguridad 1

en líneas de alimentación con toma de tierra

Datos eléctricos

Valores asignados según CEI/EN

Valores asignados según	EN 60664
Tensión nominal (III/2)	400 V
Tensión de choque asignada (II/2)	4 kV
Corriente asignada	32 A
Leyenda (valores asignados)	(III / 2) ≙ Protección contra sobretensión III / Grado de ensuciamiento 2

Datos de conexión

Número total de puntos de conexión	2
Número total de potenciales	1

Conexión 1

Tecnología de conexión	CAGE CLAMP®
Tipo de accionamiento	Palanca
Materiales de conductor conectable	Cobre
Conductor rígido	0,08 ... 2,5 mm ² / 28 ... 12 AWG
Conductor semirrígido	0,08 ... 2,5 mm ² / 28 ... 12 AWG
Conductor flexible	0,08 ... 4 mm ² / 28 ... 12 AWG
Longitud de pelado	9 ... 10 mm / 0.35 ... 0.39 pulgadas
Dirección del cableado	Conexión lateral

Datos físicos

Anchura	12,4 mm / 0.488 pulgadas
Altura	14,5 mm / 0.571 pulgadas
Profundidad	20,5 mm / 0.807 pulgadas

Datos de material

Nota sobre datos de material	Information on material data can be found here
Color	gris
Clase de inflamabilidad según UL 94	V0
Carga de fuego	0,067 MJ
Color de actuador	naranja
Peso	3,1 g

Requisitos medioambientales

Temperatura ambiente (funcionamiento)	+40 °C
Temperatura de servicio continuo	85 °C

Datos comerciales

eCl@ss 10.0	27-14-11-04
eCl@ss 9.0	27-14-11-04
ETIM 8.0	EC000446
ETIM 7.0	EC000446
PU (SPU)	500 (50) Stück
Tipo de embalaje	Box
País de origen	DE
GTIN	4050821346470
Número de arancel aduanero	85369010000

Homologaciones / Certificados

Homologaciones específicas de cada país



Homologación	Norma	Nombre de certificado
ENEC 15 UL International Demko A/S	EN 60998	ENEC-01360

Homologaciones de la industria naval



Homologación	Norma	Nombre de certificado
ABS American Bureau of Shipping	-	18-HG1755093-PDA
DNV GL Det Norske Veritas, Germanischer Lloyd	EN 60998	TAE000015T
LR Lloyds Register	EN 60998	04/20013 (E8)

UL-Approvals



Homologación	Norma	Nombre de certificado
UL UL International Germany GmbH	UL 486C	E69654

Instrucciones de manejo

Conexión del conductor

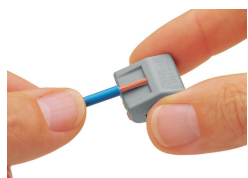

Strip conductor to 9 ... 10 mm (0.35 ... 0.39 inch).

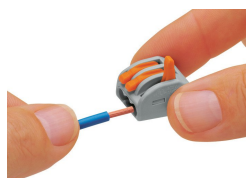

Termination: Lift the lever to open the clamping unit and insert a stripped conductor.

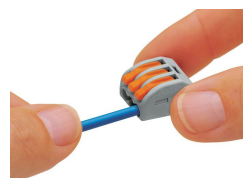

Then, lower the lever to close the clamp.

Test



Testing via Profi-LED+ voltage tester (206-806).

Aplicación

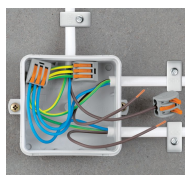

Wiring fine-stranded conductors in junction boxes.



Custom low-voltage lighting system

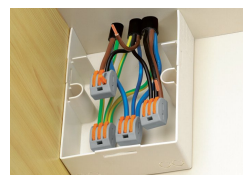

Connecting pre-wired and pre-fabricated components (e.g., in mobile homes).

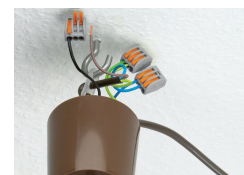

Lighting fixture connection with fine-stranded wires and power feed



Compact, lever-operated splicing connectors:

They connect up to five stripped, fine-stranded conductors from 0.08 to 4 mm² (28 ... 12 AWG), as well as solid or stranded conductors from up to 2.5 mm² (12 AWG) – without tools!

How they work:

Pull up one of the orange operating levers to open the clamping unit so that the lever engages and keeps the clamp in its opened position. Then insert the conductor and push the lever back down, flush with the connector housing.

Safety:

The lever's specially designed rest position reliably prevents accidental unclamping of a connected conductor. Application safety, for any type of conductor (solid, stranded, fine-stranded), is confirmed by approvals like ENEC or UL.

ENEC is the European mark for electrical products that demonstrates compliance with European safety standards. The ENEC mark is subjected to the same EN standards as the VDE mark.

While the VDE mark is only permitted in Germany, the ENEC mark is accepted in more than 20 European countries.